



Preparation:

- Disconnect the negative battery terminal. Park the vehicle on level ground and set the emergency brake.
- We recommend reading through the installation instructions in whole before performing the work.
- Estimated Installation Time: **2 Hours for OEM Removal/Bumper Installation**

1 Additional Hour to Wire Cube Lights

*****This installation requires 2 people for best results*****

You will need the following tools:

- | | | |
|----------------|------------------------------|----------------|
| - Ratchet | - 7mm Socket | - 10mm Socket |
| - 15mm Socket | - 16mm Socket | - 9/16" Socket |
| - Cutoff Wheel | - Epoxy or Something Similar | |

Included in Kit:

- | | |
|-----------------------------------|----------------------------------|
| 4 - Hex Head Bolts (3/8"-16 x 1") | 4 - Washers (3/8") |
| 4 - U-Nuts (3/8"-16) | 2 - License Plate Light Brackets |
| 2 - Cable Ties (8") | |

Removal:

1. From underneath the passenger side of the truck, unplug the main bumper harness connector. (Fig A)

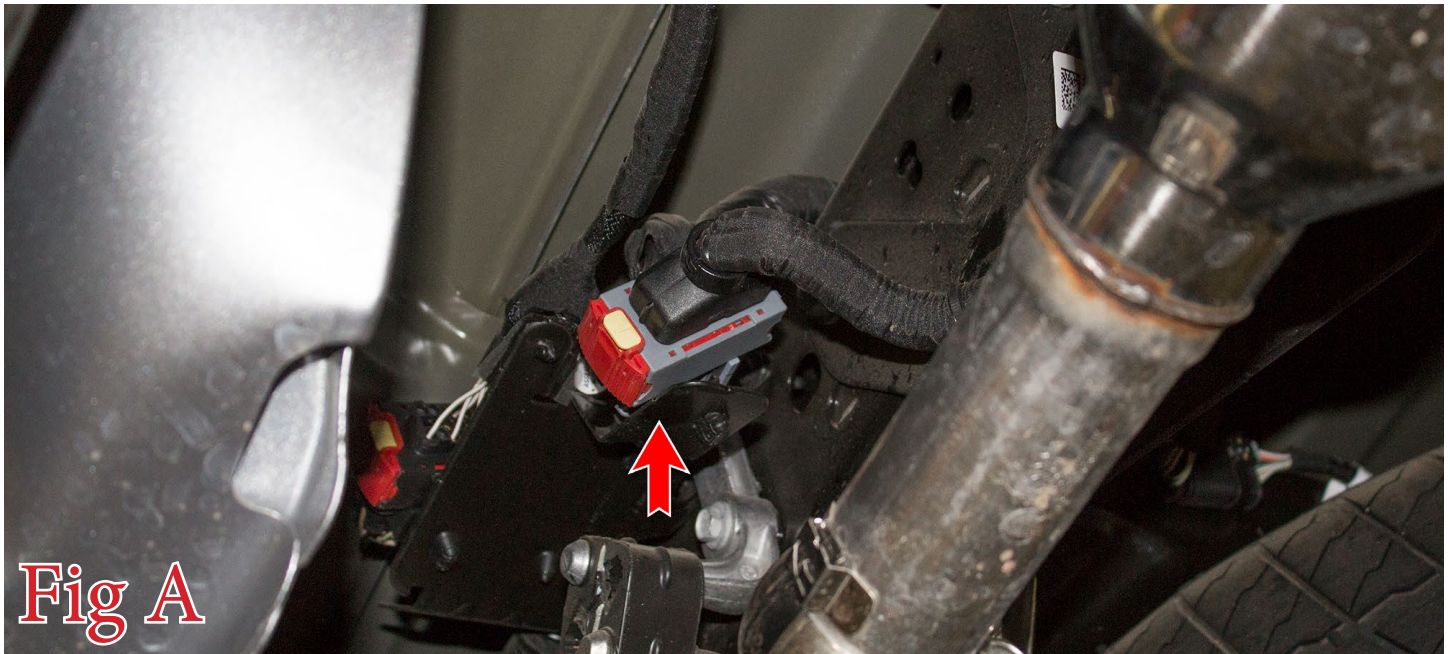



2. Remove your license plate.
3. Remove the two plastic clips that were behind the license plate. (Fig B)
4. Using a 15mm Socket, remove the two bolts that were behind the license plate. (Fig B)

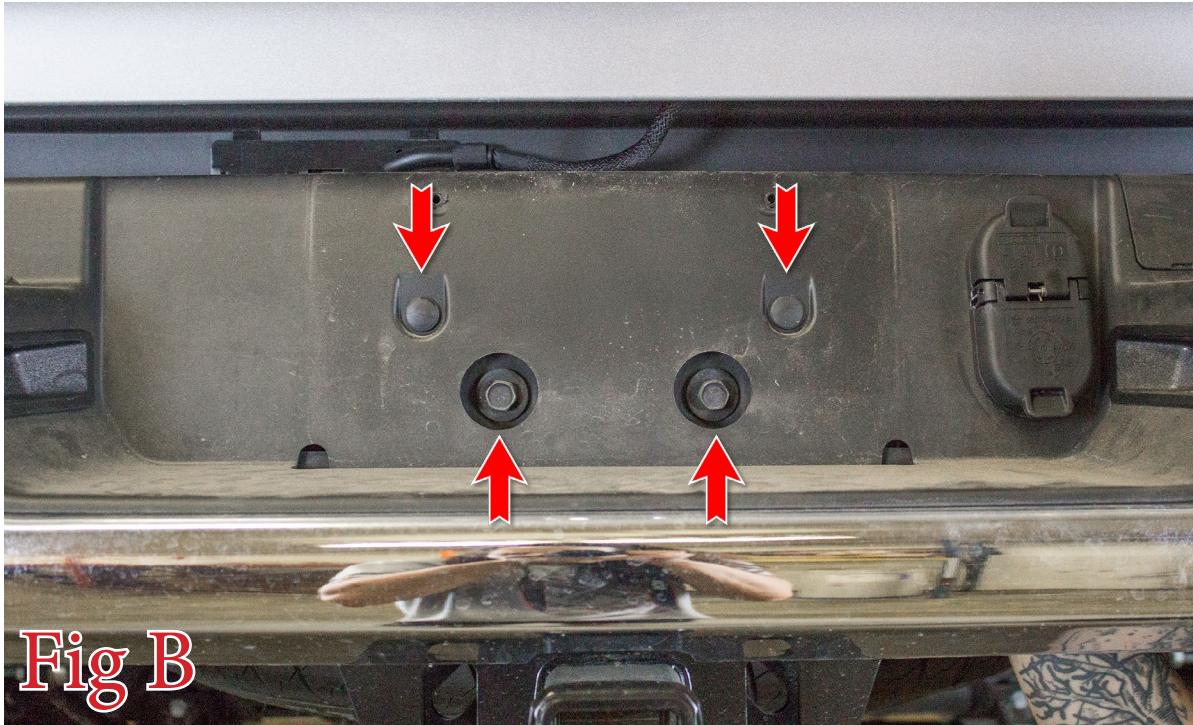

5. Unplug the connector on the back side of your trailer plug. Then, remove the trailer plug from the OEM bumper by pressing in the tabs on the back side of the plug and pushing it out the front of the bumper. (Fig C)





6. From the back side of the bumper, use a 16mm Socket to remove the two bumper mounting nuts (per side). Then, remove the OEM Bumper from the vehicle. (Fig D)



Fig D

7. Remove the key sensor from your OEM Bumper. Release the two fasteners by squeezing their tabs. Then, unplug the key sensor as you remove it from the bumper. (Fig E)

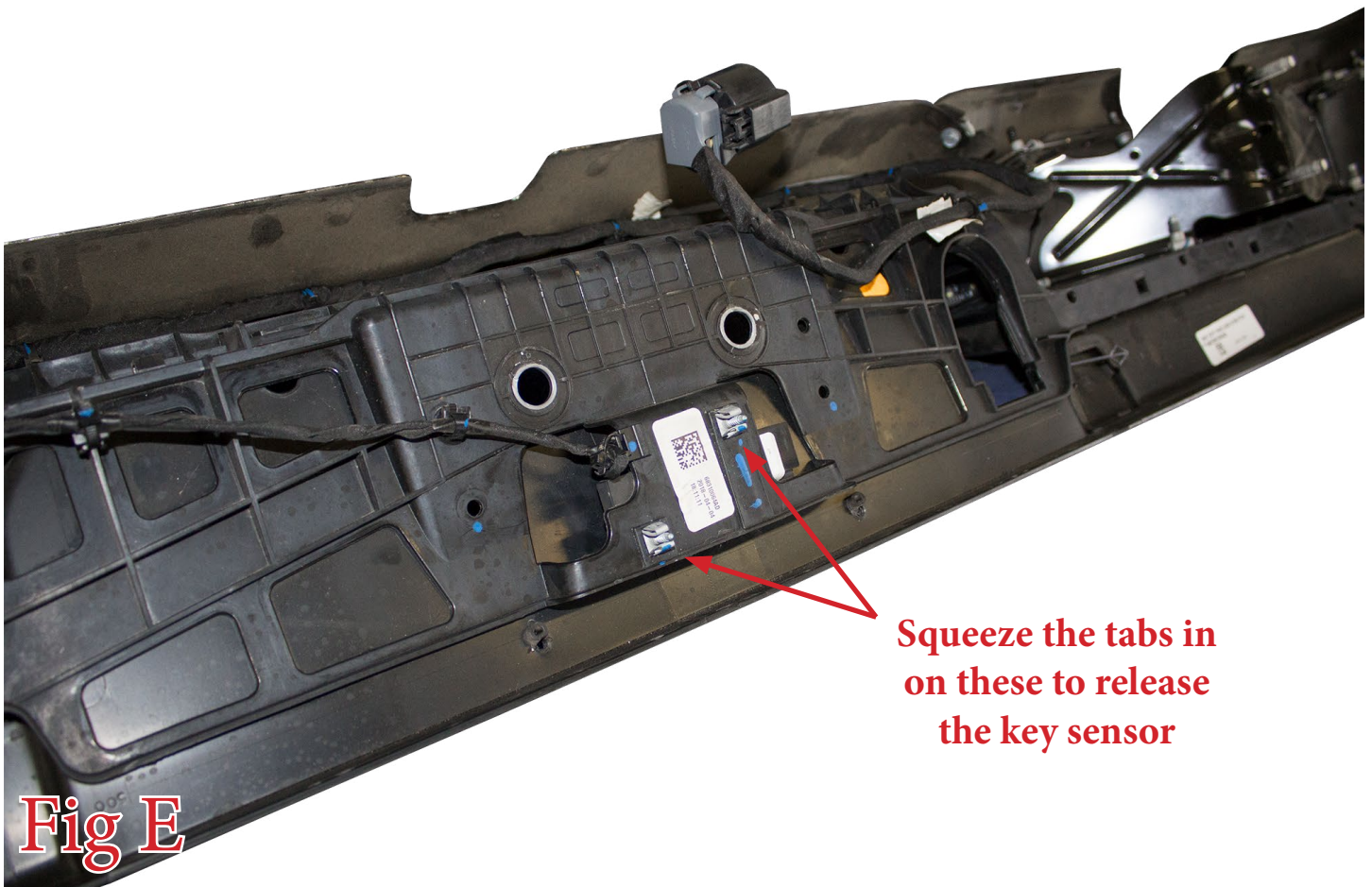
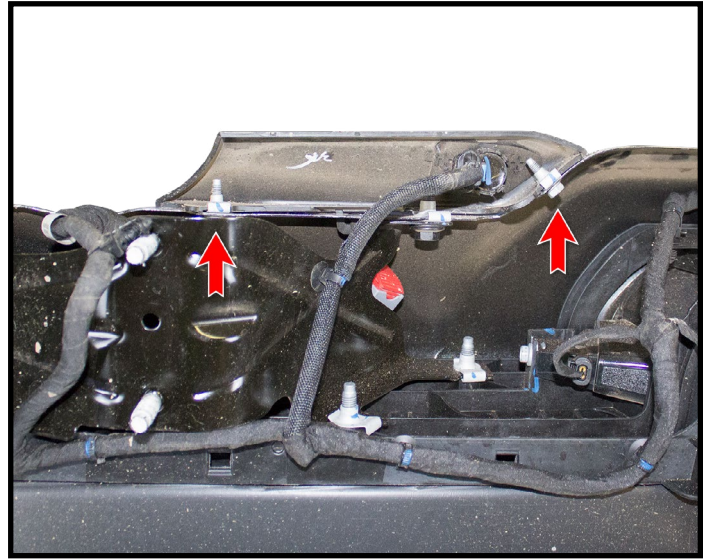
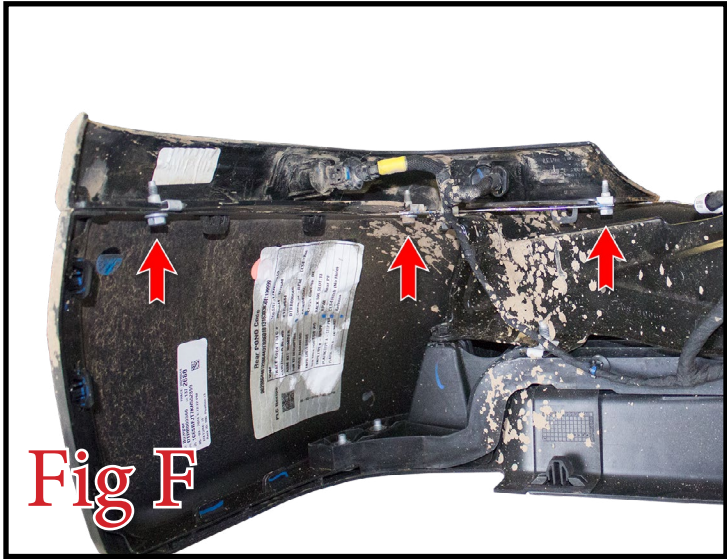

Fig E



8. Using a 10mm Socket, remove the bolts that hold on the lower plastic trim piece on the OEM bumper. There are three bolts (per side) on the corner pieces and two bolts (per side) on the center pieces. Then, remove these trim pieces from the bumper. Unplug the parking sensors as you remove the pieces. (Fig F)



9. Remove the parking sensors from their mounting rings by spreading the two tabs on the back side of the mounting rings. Keep track of what position/orientation these come off the OEM bumper so you can install them on your new bumper in the same position/orientation. (Fig G)

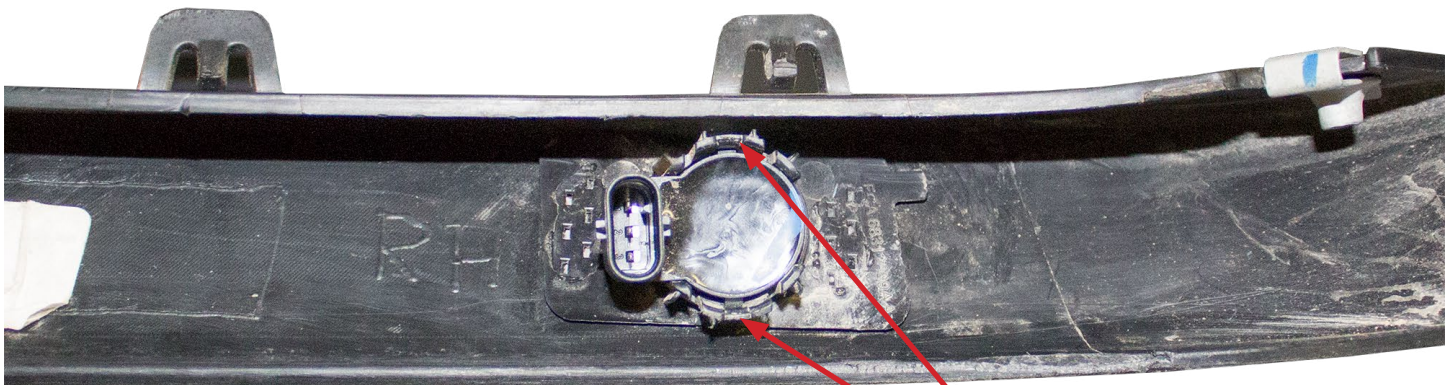

Fig G

Release the parking sensor by spreading these two tabs



10. Take a putty knife, scraper, or something similar and work it in between the sensor ring mounting plate and the plastic trim piece. Use the scraper to cut through the plastic welds holding the mounting ring plate to the trim piece. Once the plastic welds have been broken, the mounting ring will be free. (Fig H)

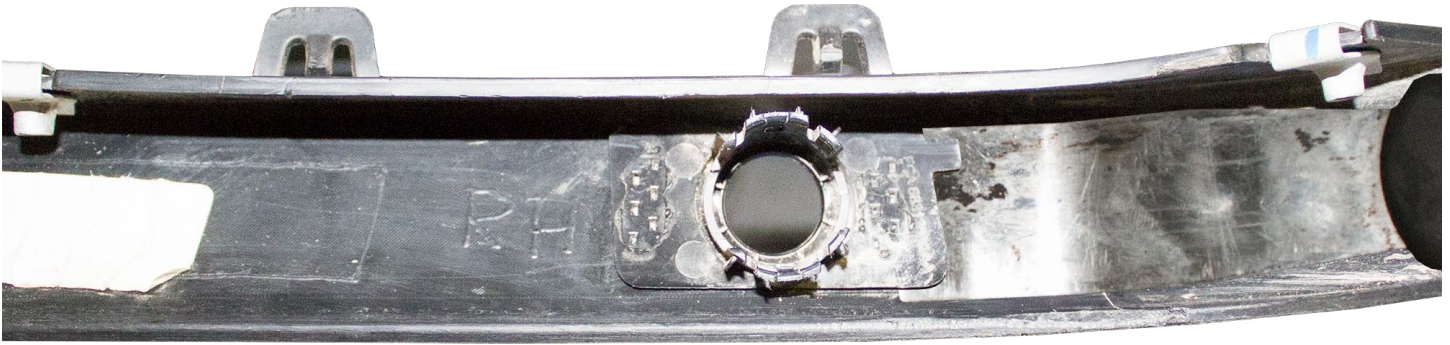

Fig H

11. With the key sensor removed from the bumper, use a 7mm Socket to remove the two bolts. (Fig I)



Fig I

12. Remove the wiring harness from the OEM bumper. Do this by releasing the series of plastic clips that hold it in place and unplugging the connector on the back side of the license plate lights.



13. Using a 10mm Socket, remove the bolt (one per side) that holds the license plate lights into place. Then, remove the license plate lights. **Save these bolts for reuse.** (Fig J)

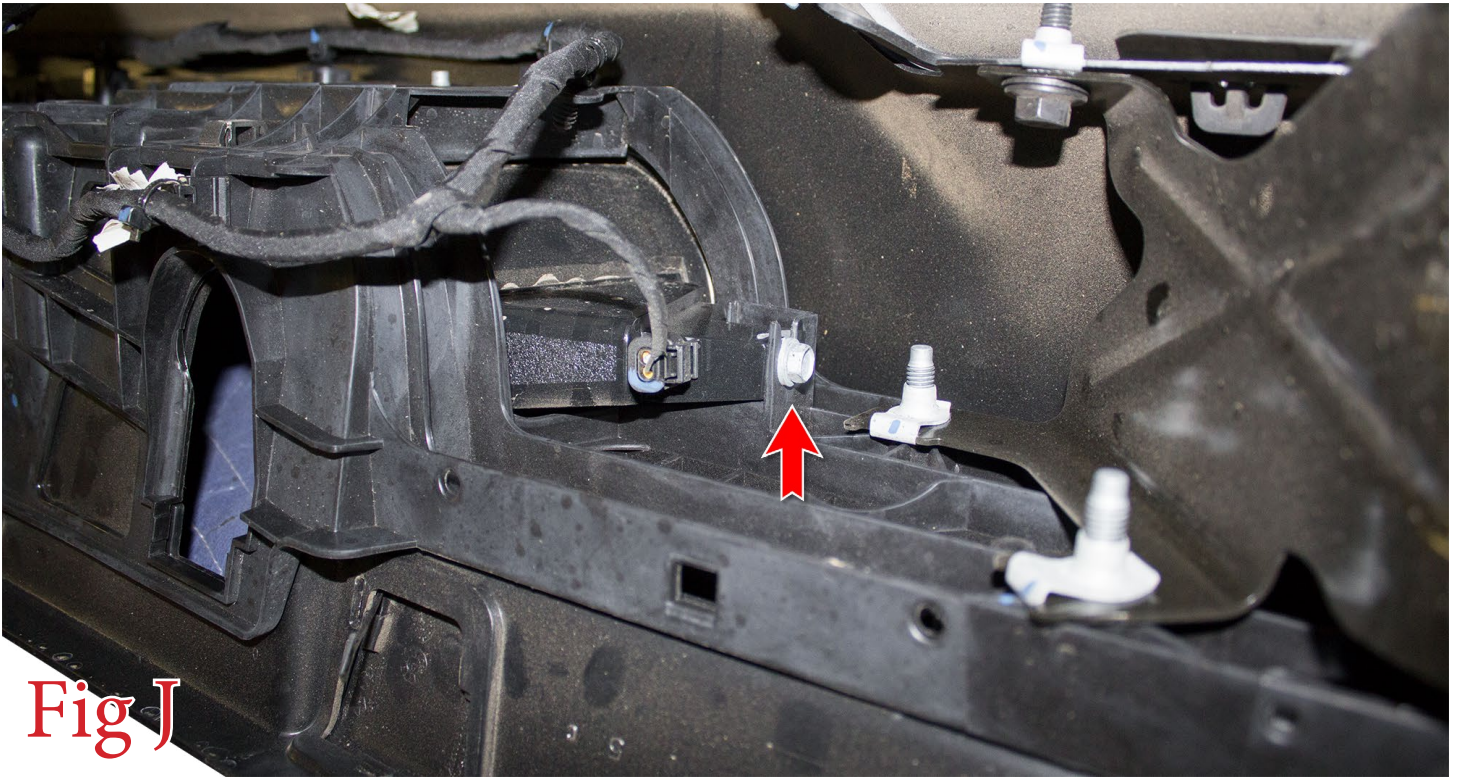

Fig J

14. Remove the nut clips that are on the bumper mounting bracket on the vehicle. (Fig K)

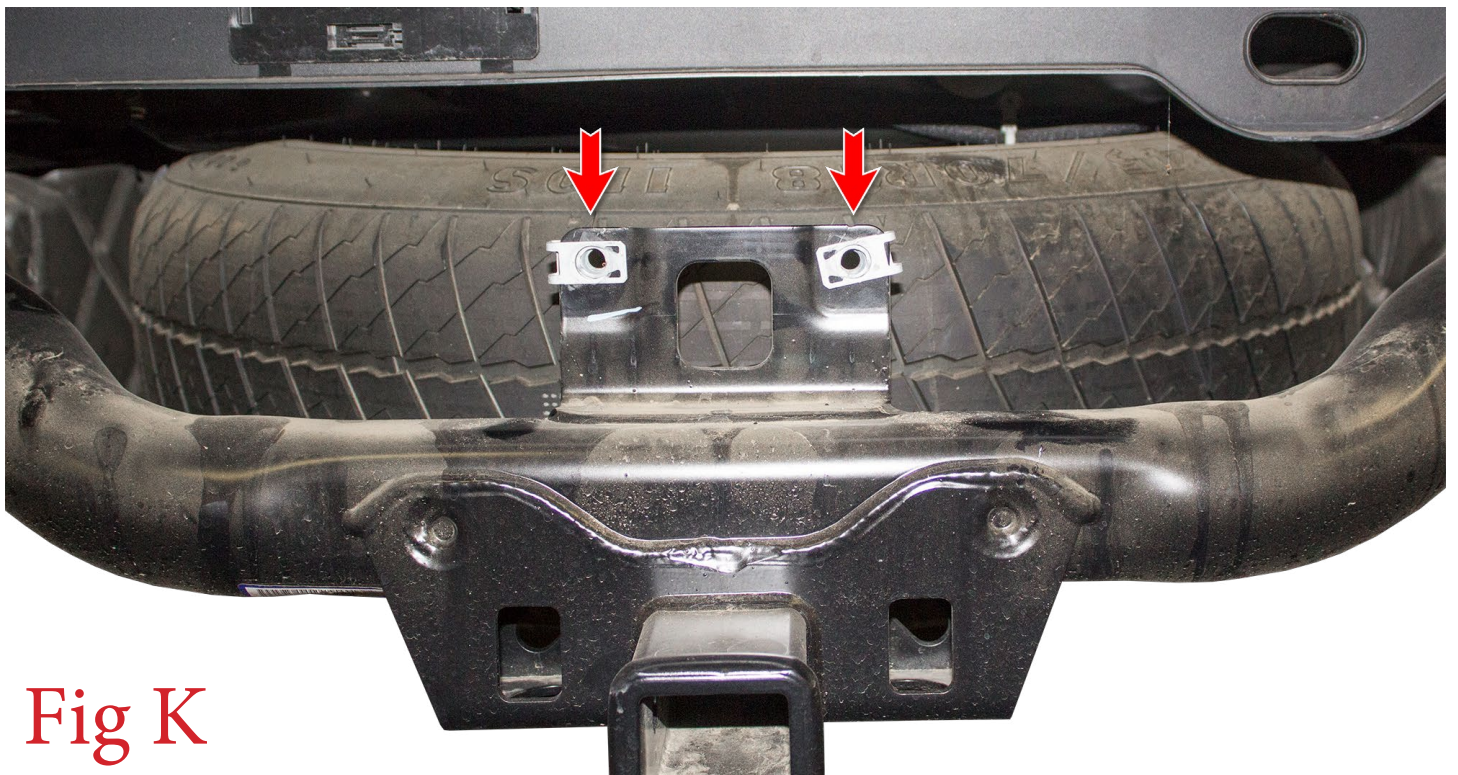

Fig K

Installation:

15. Use the supplied zip-ties (x2) to secure the key sensor to the bracket you just removed the two nut clips from. (Fig L)



16. You will have to cut the mounting plates on the center parking sensor rings. To do this, hold the sensor rings in place (make sure they are in the same position as they came off the OEM bumper) and mark them out as shown in (Fig M). Then, use a cutoff wheel or something similar to trim them to shape.

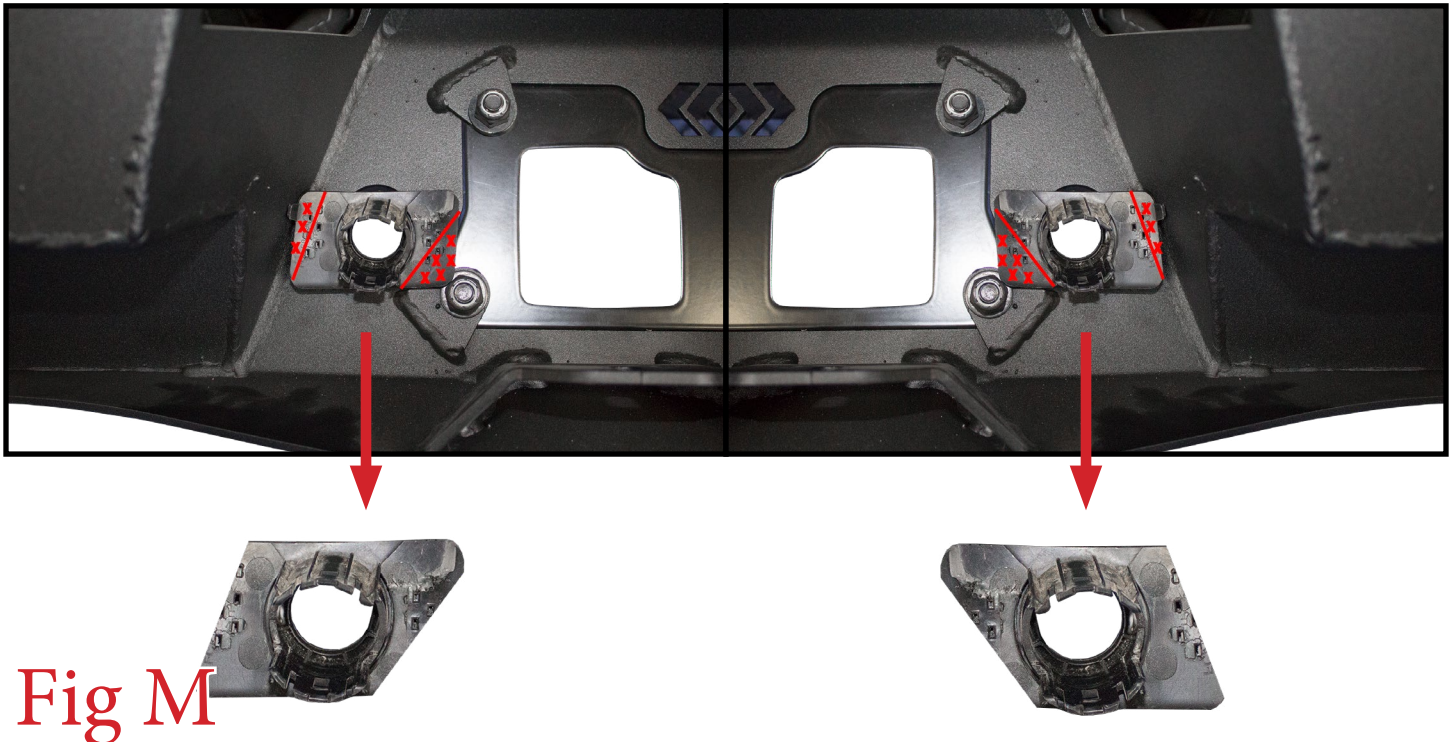



17. Install the parking sensor mounting rings onto your new bumper. Do so by applying epoxy or something similar to the front face of the mounting plate. Then, hold the mounting rings in place on the bumper until your adhesive sets. Make sure to install the sensor mounting rings in the same position/orientation as they came off the OEM bumper. (Fig N)





18. Push the parking sensors into the back side of the mounting rings until they click into place. Make sure to install them in the same orientation/order as they came off the OEM bumper. (Fig O)



19. Install the trailer plug into your new bumper by pressing it into its pre-cut hole. If your trailer plug is loose, you can spread the tabs on the back side of the trailer plug outwards to help hold it in place. (Fig P)





20. Install your license plate lights. To do this, find the supplied license plate light brackets (x2). Then, install the license plate lights using the supplied brackets and the bolts you saved in Step 13. Make sure to install both the license plate lights and the mounting bracket in the correct orientation. You will have to switch the license plate lights so the one that came off the left side of the OEM bumper gets installed on the right side of your new bumper and vice versa. Match the shape of the light to the shape of the hole. Install the bracket with the wider tab towards the top of the bumper. (Fig Q) **DO NOT OVERTIGHTEN THE MOUNTING BOLTS OR YOU WILL BREAK THE LIGHT HOUSINGS.** Tighten the bolts until the lights aren't loose anymore and stop. (Fig R)

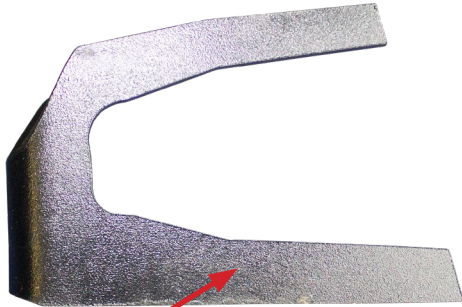

Make sure the wider tab is closer to the top of the bumper

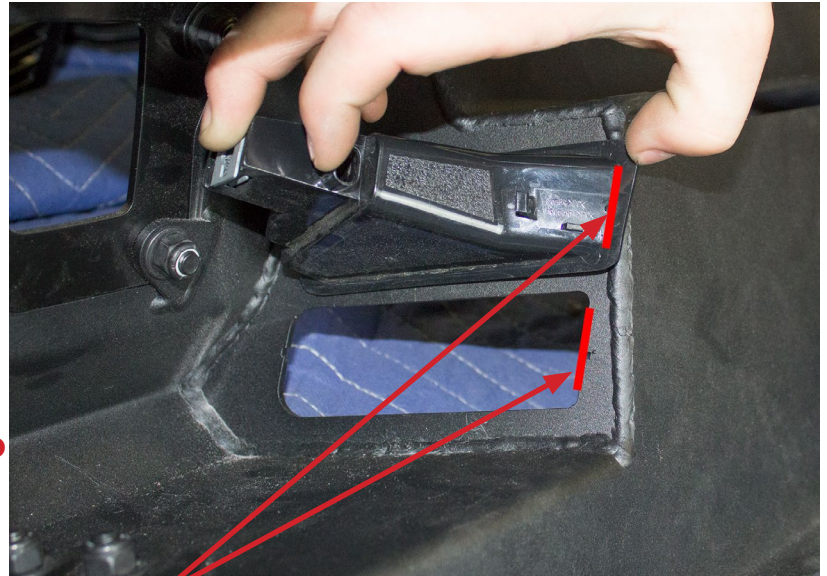

Make sure the angle on the light matches the angle of the cutout

Fig Q

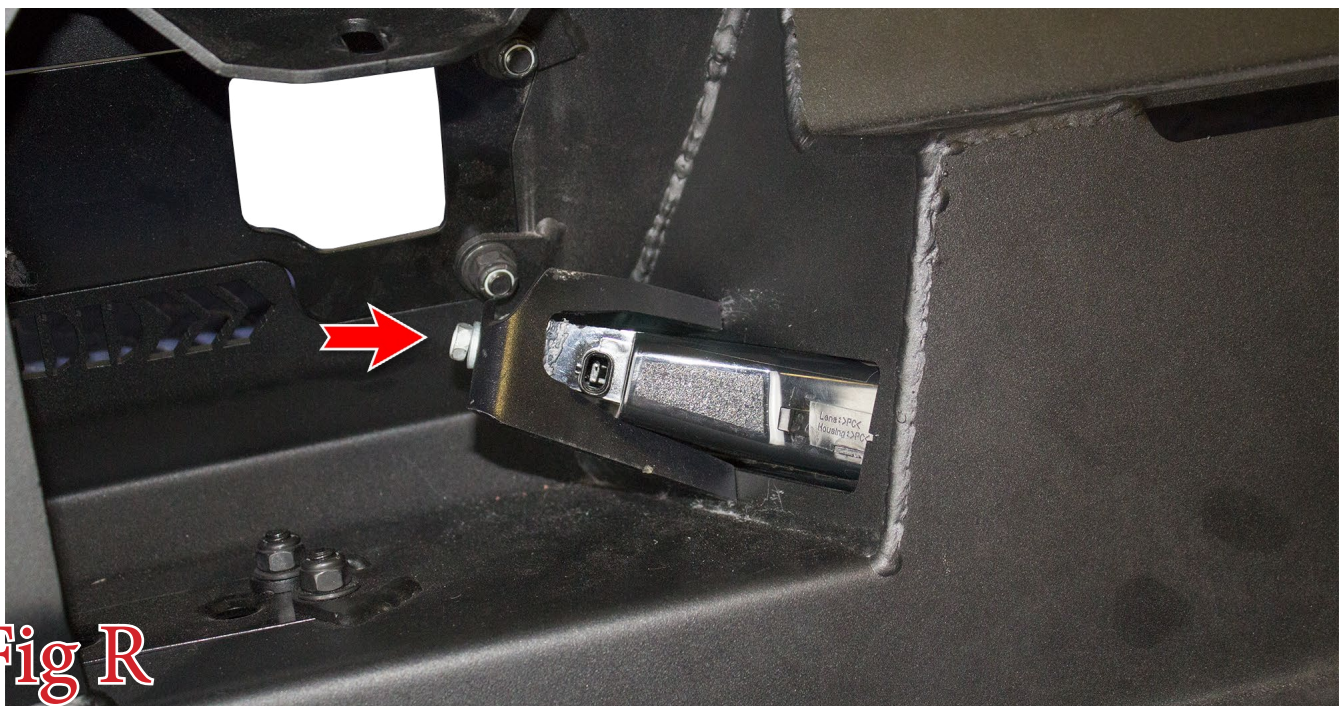

Fig R



21. If you have lights to install on your bumper, now is a good time to do so. Please follow the light manufacturer's guide for mounting/wiring information.
22. Install the supplied U-Nuts (x4) on your new bumper's mounting holes. (Fig S)

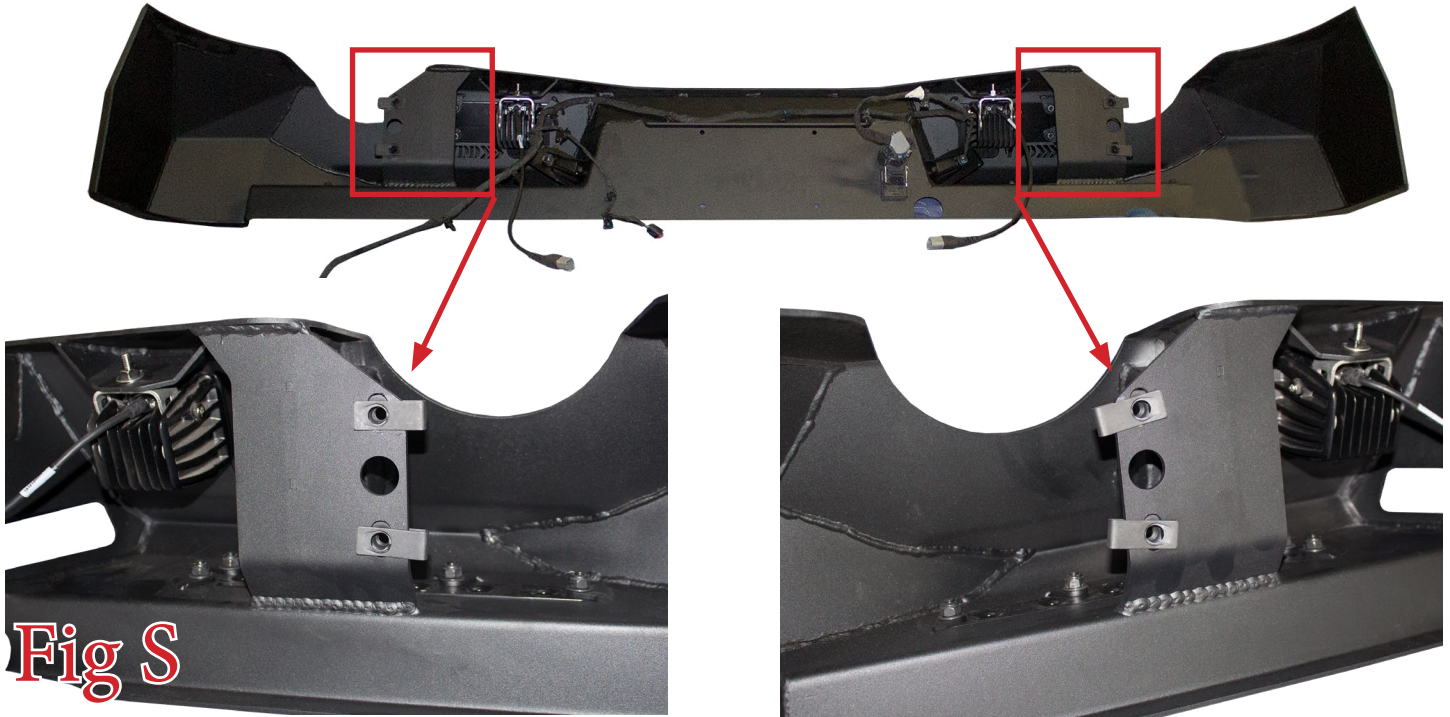

Fig S

23. Install the bumper harness on your new bumper by plugging it the license plate lights and parking sensors. (Fig T)



Fig T



24. Set the bumper in place on the vehicle, lining the mounting holes on the vehicle's frame horns up with the newly installed U-Nuts on the bumper. Then, secure the bumper to the vehicle using the supplied 3/8" Bolts (x4) and 3/8" Washers (x4). Leave these bolts loose for now. (Fig U)

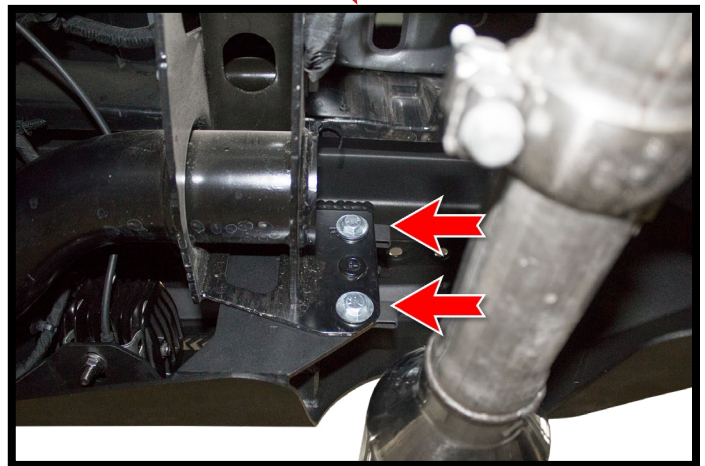
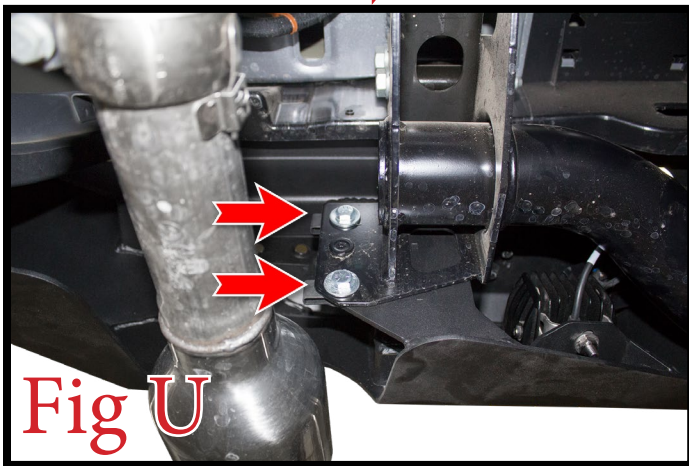
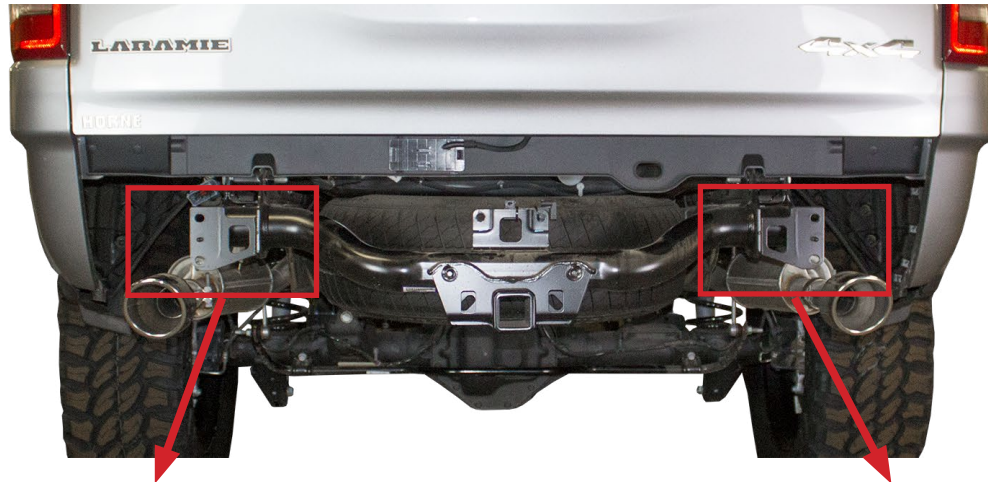

25. Align the bumper so that it is straight in relation to the tailgate and is centered left to right. Then, tighten the 3/8" Mounting Bolts to 25 foot pounds.
26. Plug in the key sensor connector.
27. Plug in the connector from Step 1.
28. Stand back and enjoy your new ADD Stealth Fighter™ Rear Bumper.
29. Check and re-tighten, if needed, all mounting bolts after 100 miles and periodically thereafter.

