

BRONCO CAMERA RELOCATION KIT

2021+ FORD BRONCO

ABBR-03



TOOLS REQUIRED

- 13mm, 16mm Socket
- 17mm Wrench
- Trim Clip Tool
- 4mm, 5mm Allen Bit
- T30 Torx Bit
- Zip Ties

SKILL LEVEL

- Novice/Intermediate
 - 1 (you) to 2 persons
- Novice skill level required, you can install it by yourself however, additional help will be useful.

TIME REQUIRED

- 2.5 Hours
- Time to install this should only take about two and a half hours.

WARNINGS/CAUTIONS BEFORE STARTING INSTALLATION

Before you install this kit – Read and understand all instructions, warnings, cautions, and notes contained in this installation instruction guide. Consult your vehicle owner’s manual for proper disconnection of electrical and lifting of vehicle if required for installation of this product.

This install may require some technical skills and knowledge of basic mechanical work. If you do not feel that you are capable of performing this install please take this product to a trained professional.

After reading this guide please contact us with any questions or concerns before installing product.
Customer Service: 855-680-9595

DV8 Offroad is not responsible for any bodily injury or harm to you or your vehicle as a result of an improper install.

Proper installation of this kit required knowledge of the factory recommended procedures for removal and installation of original equipment components. We recommend that the factory shop manual and any special tools needed to service your vehicle be on hand during the installation. Installation of this kit without proper knowledge of the factory recommended procedures may affect the performance of these components and the safety of the vehicle

- Always wear eye protection when operating power tools

Inspect all contents of this package to make sure product is not damaged and all installation hardware has been included. If parts are missing from kit, please be prepared to provide the following information

1. Name of purchase location
2. Bar Code on side of box
3. Date above bar code
4. Date inside box cover



INSTALLATION MANUAL

Begin by unpacking all items and inspecting for missing pieces or damage. If you have any concerns, please contact the company the product was purchased from. Extra hardware may be included with the product.

HARDWARE INCLUDED

- | | |
|-------------------------|----------------------------|
| (2) M10x50 Hex | (8) M8 Flat Washers |
| (2) M10 Flat Washers | (4) Spring Washers |
| (2) M10 Nylon Lock Nuts | (4) M8 Nuts |
| (2) M6x20 Allen | (2) Barbed Hose Connectors |
| (4) M6 Washer | (1) Camera Wire Extension |
| (2) M6 Serrated Nut | (1) Spray Hose Extension |
| (4) M8x25 Allen | |

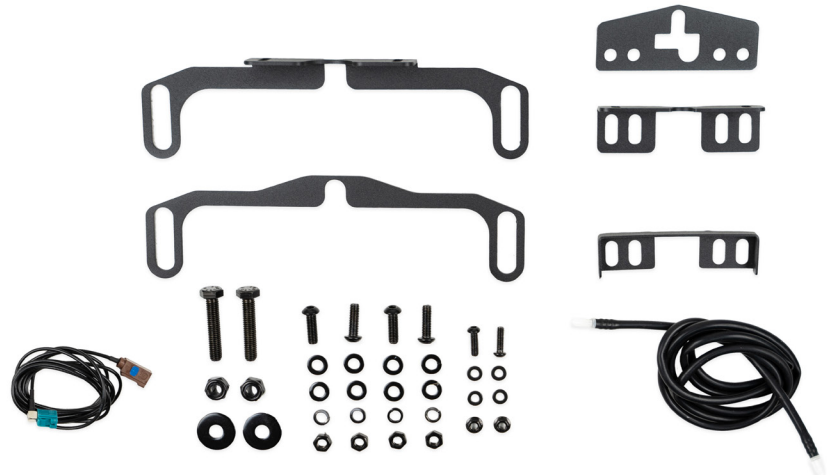

STEP 1 | Use a trim clip tool to remove the clips securing the plastic trim to the top of the grille.



STEP 2 | Move the air intake cowl up/back and out of the way.



INSTALLATION MANUAL

STEP 3 | Remove the plastic trim and place it off to the side.



STEP 4 | Disconnect the camera wiring connector by pressing the release tab and pulling.

Disconnect the spray hose connector located above the passenger's head light.



STEP 5 | If your vehicle is equipped with adaptive cruise control, disconnect it now by pressing the release tab and gently pulling on the connector.



INSTALLATION MANUAL

STEP 6 | Use a 13mm socket to remove the hardware securing the grille assembly to the vehicle.

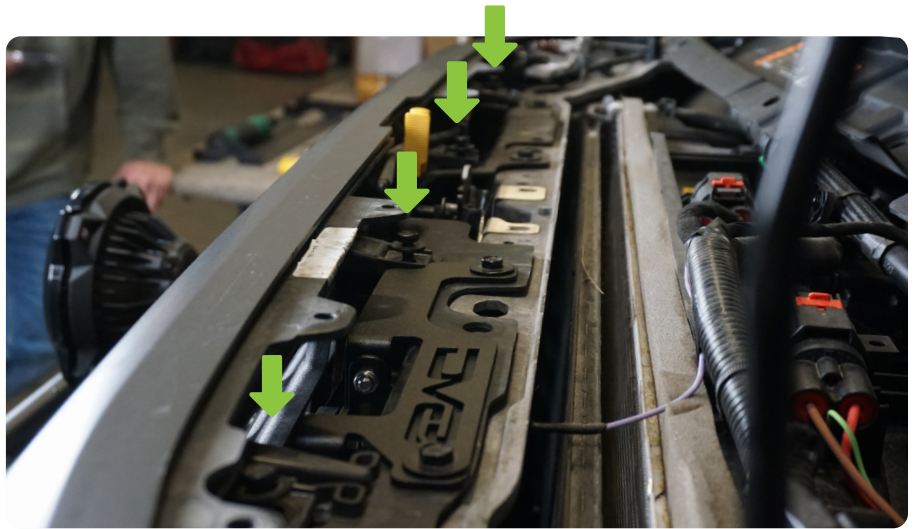

STEP 7 | If this product is being installed on a raptor, there are two additional steps to perform.

Disconnect the raptor accessory lighting located above the driverside headlight by pressing the release tab and pulling.

Remove the valance by grabbing the bottom of the clip on each side as shown and pull away from the bronco to release the side of the valance.

Pull the center of the valance away from the bronco to release the clips and set off to the side on a soft surface.



INSTALLATION MANUAL

STEP 8 | To remove the grille, pull carefully on the grille towards the front of the vehicle to un-fasten the clips securing the grille. Start at the sides and work towards the middle.

Place the grill off to the side on a soft work surface to prevent damage to the grille.

Note: If you do not pull straight away from the vehicle, you may damage the clips on the grille.

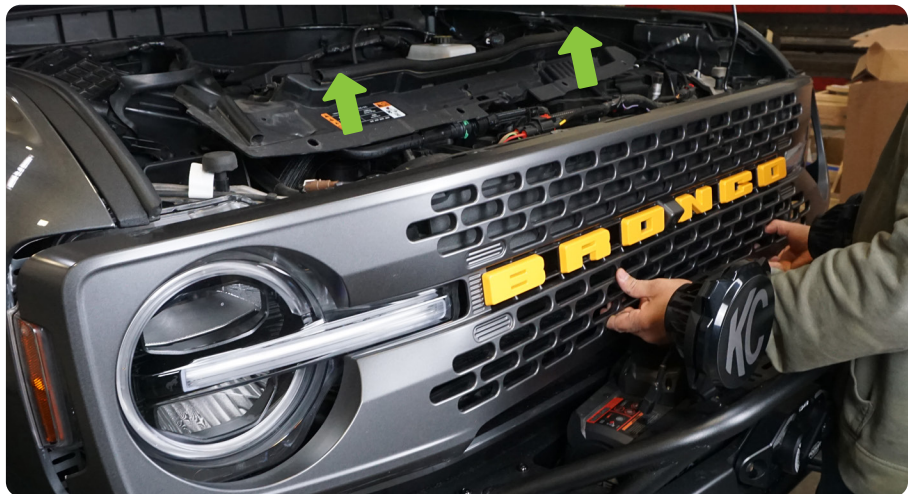

INSTALLATION MANUAL

STEP 9 | Remove the camera wiring connector from the camera by pressing the release tab and gently pulling.

Remove the camera hose from the camera assembly by pulling it out of place.



STEP 10 | Use a trim clip tool to remove the clips securing the camera hose to the grille and place it off to the side.



INSTALLATION MANUAL

STEP 11 | Use a trim clip tool to remove the clips securing the camera wiring to the grille and place it off to the side.

The factory camera wire will not be re-used during installation.



STEP 12 | Use a T30 torx bit to remove the bolts securing the camera housing assembly bracket and set it off to the side.

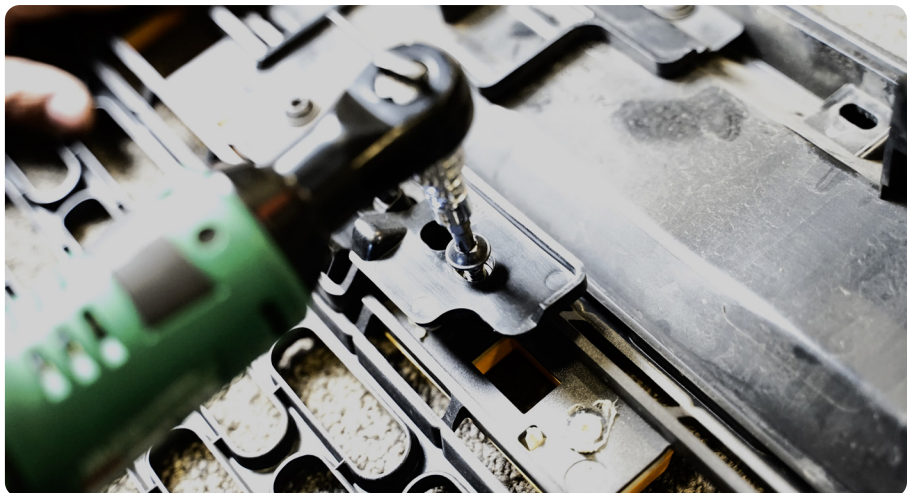

INSTALLATION MANUAL

STEP 13 | Remove the camera housing bracket and place it off to the side.

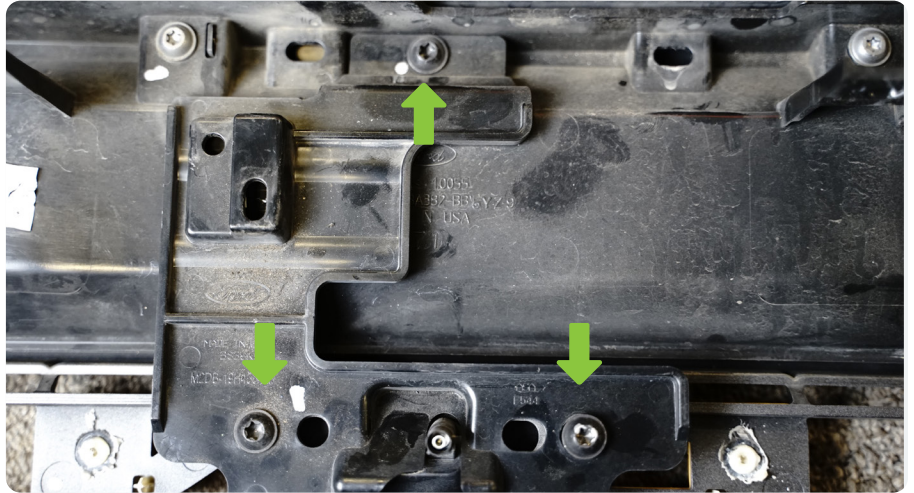

STEP 14 | You can now remove the camera housing assembly.



INSTALLATION MANUAL

STEP 15 | Begin assembling the mounting brackets to the camera housing.

Place the face plate on the housing, followed by small “L” shaped bracket.

Note the orientation of the “L” shaped bracket in the image.



STEP 16 | Place the mount cover over it, and loosely secure with the provided M8 hardware.



INSTALLATION MANUAL

STEP 17 | Loosely secure the second, larger “L” shaped bracket to the camera assembly using the provided M6 hardware.



STEP 18 | Align the camera assembly and brackets so that the camera is sitting straight and even on the bracket.

Then, secure the M8 hardware using a 5mm allen bit.



STEP 19 | Install the included extended camera wire to the camera.

When installing the hose to the assembly, be sure to install it in the manner it was removed.

The factory hose has a check valve directly behind the elbow. Connect the elbow to the camera assembly so the check valve is directly behind it.

Later in the instructions, the gap will be bridged using the provided barbs and hose extension.



INSTALLATION MANUAL

STEP 20 | Place the larger “U” shaped bracket up to the assembly.

Run the wiring and hose so that it goes under the “U” in the bracket. The wiring and hose should not be pinched in any way.



STEP 21 | Align the upper bracket so that it is straight and even, then secure the M6 hardware using a 4mm allen bit.



STEP 22 | Place the entire assembly behind the fairlead.



INSTALLATION MANUAL

STEP 23 | Feed the winch cable through the fairlead and the camera wire and washer hose over the top of the fairlead.

If your bumper has a closed top portion on the fairlead mount like the DV8 FBBR-01, then feed the camera wire and washer hose through the fairlead hole.

Then, install the camera assembly/ bracket behind the fairlead and secure using the provided M10 hardware with a 16mm socket and 17mm wrench.



INSTALLATION MANUAL

STEP 24 | Double check that the wires and hose are not pinched and that the camera assembly is sitting straight and even the bracket.

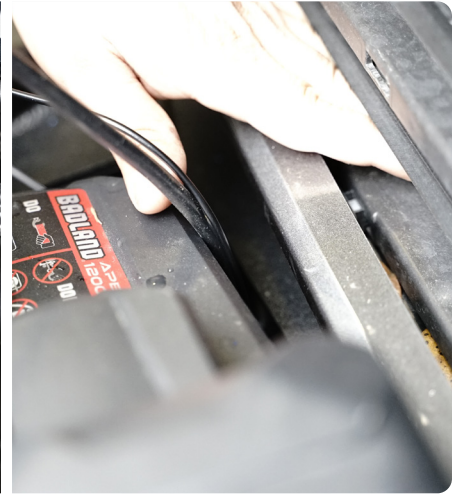

STEP 25 | For our install we routed under the grille, behind the passenger side headlight.

To extend the hose, first separate the hose into two pieces by removing the connection located directly behind the check valve.

Remove the remaining plastic connector, and use the provided barbs to install the hose extension.

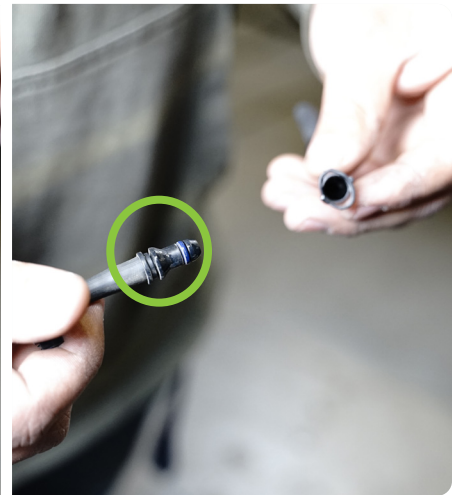

STEP 26 | Connect the camera wiring harness by pressing it into place until the clip is secure.

Then, connect the factory hose connectors to the factory hose line on the vehicle.



INSTALLATION MANUAL

STEP 27 | Carefully place the grille into place and secure it by pressing/ applying pressure to the grille to press the clips into place.

Ensure the grille and clips are aligned and straight before applying pressure or you may break the clips.



STEP 28 | Use a 13mm socket and the factory hardware to secure the grille to the vehicle.



STEP 29 | Place the plastic grille trim back into place above the grille and pull the factory air intake cowl. Secure using the factory plastic grille trim using the factory push clips.



INSTALLATION MANUAL

STEP 30 | Double check fitment and all hardware is secure.

Congrats! You are finished with the install of the 2021+ Ford Bronco Camera Relocation Bracket.

